

# 3-JAW CONCENTRIC GRIPPERS

## SERIES GD1700

1

Series GD1700 / 3-Jaw Concentric Grippers / pneumatic / Grippers

### Installation Size: GD1704

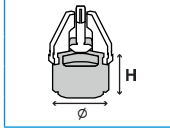

Dimension	
Ø [mm]	Height** [mm]
57	51

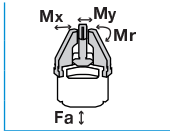

Force and moment			
Mr [Nm]	Mx [Nm]	My [Nm]	Fa [N]
8	12	8	300

Technical Data*				
Order no.	Stroke per jaw [mm]	Gripping force [N]		Weight [kg]
		opening	closing	
GD1704N-B	4	280	280	0.35
GD1704NC-B	4	400	400	0.41
GD1704NO-B	4	400	400	0.41

\*All data measured at 6 bar

\*\* Version with gripping force protection (NC, NO)

### Gripping force diagram

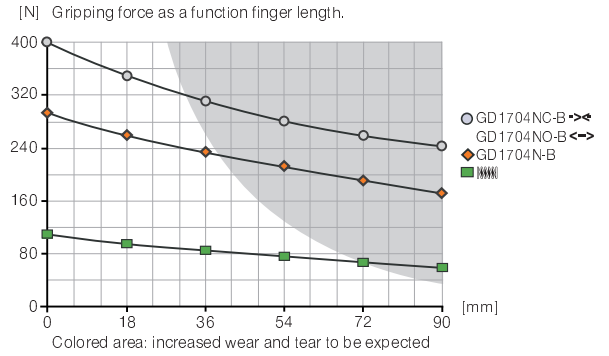

### Installation Size: GD1706

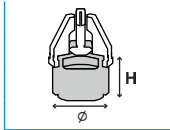

Dimension	
Ø [mm]	Height** [mm]
74	66

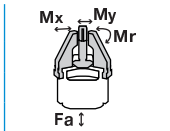

Force and moment			
Mr [Nm]	Mx [Nm]	My [Nm]	Fa [N]
20	25	18	700

Technical Data*				
Order no.	Stroke per jaw [mm]	Gripping force [N]		Weight [kg]
		opening	closing	
GD1706N-B	6	380	380	0.65
GD1706NC-B	6	560	560	0.85
GD1706NO-B	6	560	560	0.85

\*All data measured at 6 bar

\*\* Version with gripping force protection (NC, NO)

### Gripping force diagram

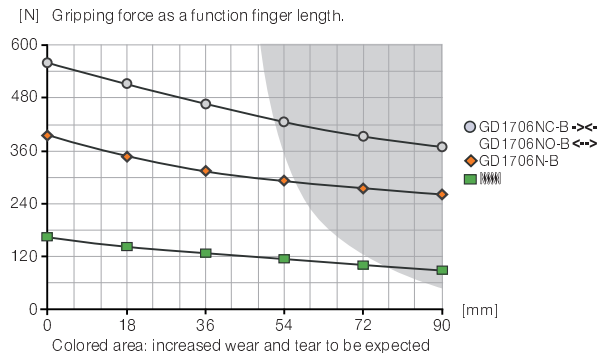

## Installation Size: GD1708

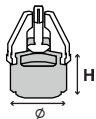

### Dimension

Ø [mm]	Height** [mm]
92	83.5

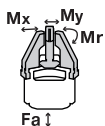

### Force and moment

Mr [Nm]	Mx [Nm]	My [Nm]	Fa [N]
30	45	30	1300

### Technical Data\*

Order no.	Stroke per jaw [mm]	Gripping force [N]		Weight [kg]
		opening	closing	
GD1708N-B	8	660	660	0.9
GD1708NC-B	8		960	1.5
GD1708NO-B	8	960		1.5

\* All data measured at 6 bar

\*\* Version with gripping force protection (NC, NO)

### Gripping force diagram

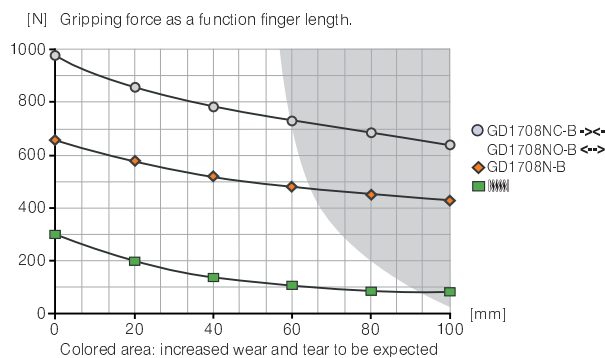

## Installation Size: GD1710

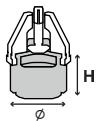

### Dimension

Ø [mm]	Height** [mm]
114	104

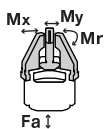

### Force and moment

Mr [Nm]	Mx [Nm]	My [Nm]	Fa [N]
50	70	45	2300

### Technical Data\*

Order no.	Stroke per jaw [mm]	Gripping force [N]		Weight [kg]
		opening	closing	
GD1710N-B	10	960	960	2.4
GD1710NC-B	10		1400	2.8
GD1710NO-B	10	1400		2.8

\* All data measured at 6 bar

\*\* Version with gripping force protection (NC, NO)

### Gripping force diagram

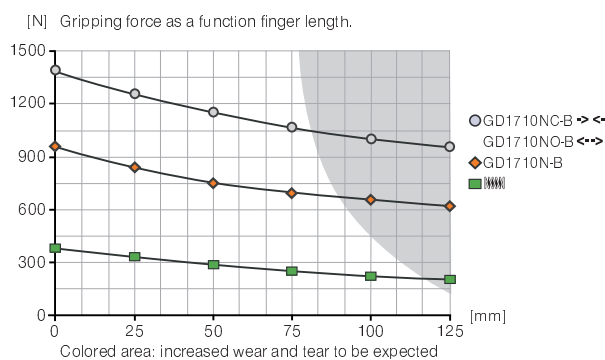

# 3-JAW CONCENTRIC GRIPPERS

## SERIES GD1700

1

Series GD1700 / 3-Jaw Concentric Grippers / pneumatic / Grippers

### Installation Size: GD1712

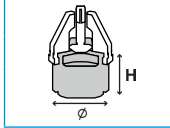

Dimension	
Ø [mm]	Height** [mm]
139	120.5

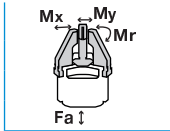

Force and moment			
Mr	Mx	My	Fa
[Nm]	[Nm]	[Nm]	[N]
75	100	65	3600

Technical Data*			
Stroke per jaw [mm]	Gripping force [N]		Weight [kg]
	opening	closing	
<b>GD1712N-B</b>	12	1700	3.6
<b>GD1712NC-B</b>	12	2250	5.3
<b>GD1712NO-B</b>	12	2250	5.3

\*All data measured at 6 bar

\*\* Version with gripping force protection (NC, NO)

### Gripping force diagram

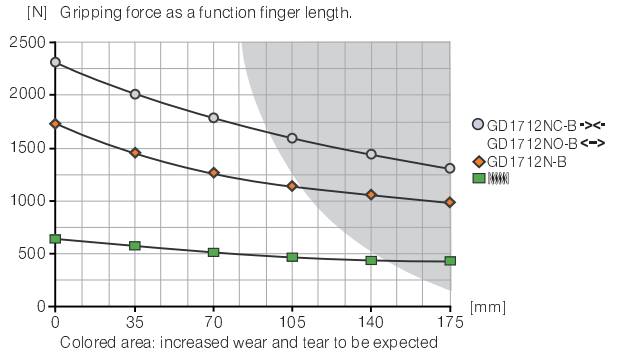

### Installation Size: GD1716

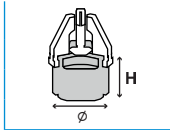

Dimension	
Ø [mm]	Height** [mm]
179	153.5

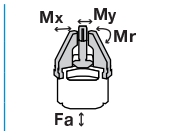

Force and moment			
Mr	Mx	My	Fa
[Nm]	[Nm]	[Nm]	[N]
95	100	85	5200

Technical Data*			
Stroke per jaw [mm]	Gripping force [N]		Weight [kg]
	opening	closing	
<b>GD1716N-B</b>	16	3500	6.5
<b>GD1716NC-B</b>	16	4700	8.5
<b>GD1716NO-B</b>	16	4700	8.5

\*All data measured at 6 bar

\*\* Version with gripping force protection (NC, NO)

### Gripping force diagram

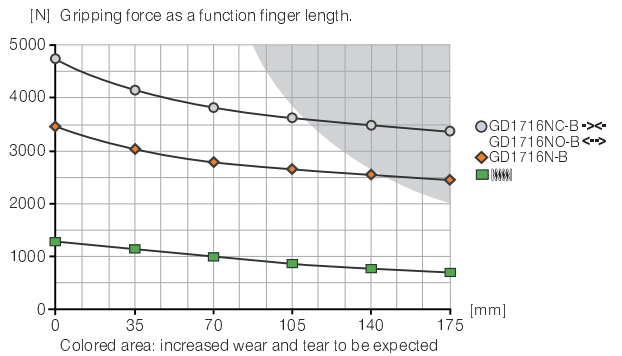

## Installation Size: GD1720

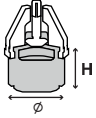

Dimension	
∅	Height
[mm]	[mm]
218	122

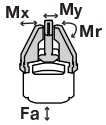

Force and moment			
Mr	Mx	My	Fa
[Nm]	[Nm]	[Nm]	[N]
120	140	105	7000

Technical Data*				
Stroke per jaw	Gripping force [N]		Weight	
	[mm]	opening		closing
GD1720N-B	20	5250	5250	13.4

\*All data measured at 6 bar

### Gripping force diagram

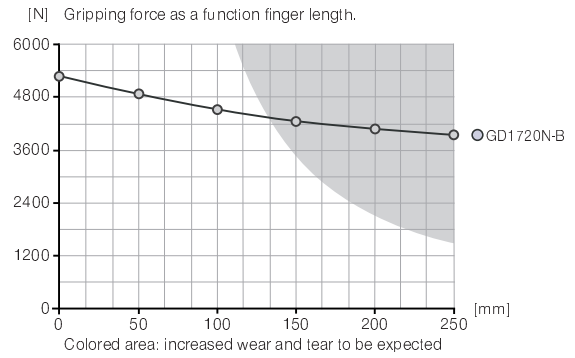

# 3-JAW CONCENTRIC GRIPPERS

## SERIES GD1700

### ▶ ACCESSORIES

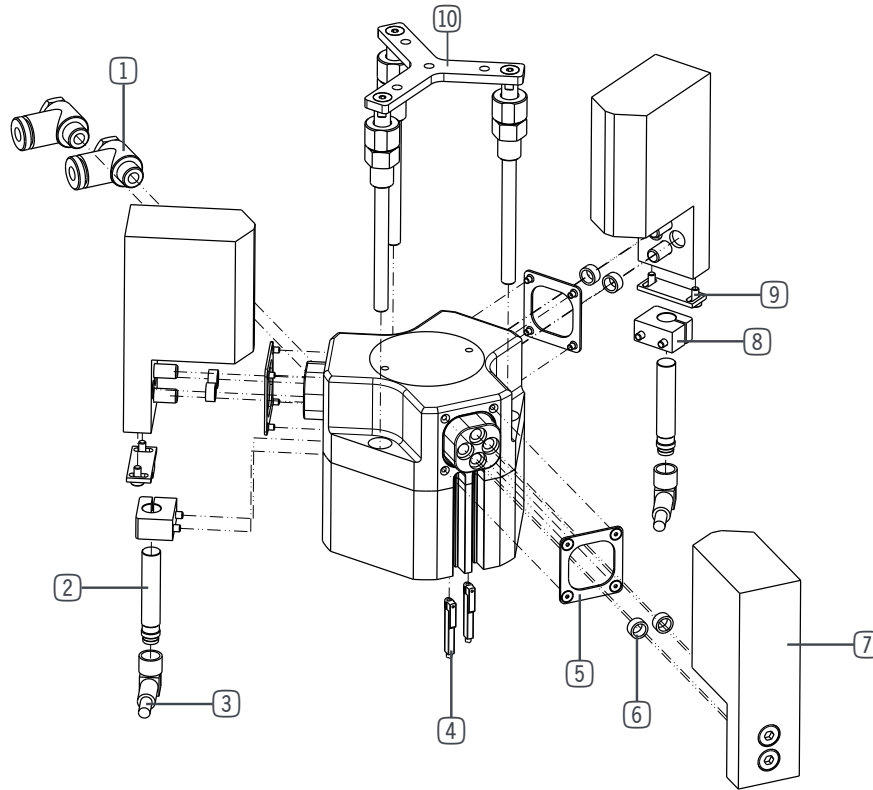

#### ▶ Installation Size: **GD1704**

Pos.	Accessories	Order no.
①	Straight Fittings - Quick Connect Style	<b>GV1-8X6</b>
②	Inductive proximity switch - Cable 5 m	<b>NJ3-E2</b>
②	Inductive Proximity Switch Cable 0,3 m - Connector M8	<b>NJ3-E2SK</b>
③	Plug-in connector Straight Cable 5m - Socket M8 (female)	<b>KAG500</b>
③	Plug-in connector Angled Cable 5m - Socket M8 (female)	<b>KAW500</b>
④	Magnetic field sensor Angled Cable 5 m	<b>MFS103KHC</b>
④	Magnetic field sensor Angled Cable 0,3 m - Connector M8	<b>MFS103SKHC</b>
④	Magnetic field sensor Straight Cable 5 m	<b>MFS204KHC</b>
④	Magnetic field sensor Straight Cable 0,3 m - Connector M8	<b>MFS204SKHC</b>
⑤	Cover plate	<b>ADB1704-B</b>
⑦	Universal Jaw Aluminium	<b>UB1704</b>
⑦	Universal Jaw Steel	<b>UB1704ST</b>
⑧ ⑨	Set of clamping blocks	<b>KB1700-01</b>
⑩	Pressing star	<b>ADS1704C-O</b>
⑩	Pressing star	<b>ADS1704N-S</b>
	Pressure Safety Valve	<b>DSV1-8</b>
	Plug-in connector customizable Straight - Connector M8	<b>S8-G-3</b>
	<b>Delivery contents</b>	<b>Order no.</b>
⑥	Centering Disc	<b>BDST40400</b>

#### ▶ Installation Size: **GD1706**

Pos.	Accessories	Order no.
①	Straight Fittings - Quick Connect Style	<b>GV1-8X6</b>
②	Inductive proximity switch - Cable 5 m	<b>NJ8-E2</b>
②	Inductive proximity switch - Connector M8	<b>NJ8-E2S</b>
③	Plug-in connector Straight Cable 5m - Socket M8 (female)	<b>KAG500</b>
③	Plug-in connector Angled Cable 5m - Socket M8 (female)	<b>KAW500</b>
④	Magnetic field sensor Angled Cable 5 m	<b>MFS103KHC</b>
④	Magnetic field sensor Angled Cable 0,3 m - Connector M8	<b>MFS103SKHC</b>
④	Magnetic field sensor Straight Cable 5 m	<b>MFS204KHC</b>
④	Magnetic field sensor Straight Cable 0,3 m - Connector M8	<b>MFS204SKHC</b>
⑤	Cover plate	<b>ADB1706-B</b>
⑦	Universal Jaw Aluminium	<b>UB1706</b>
⑦	Universal Jaw Steel	<b>UB1706ST</b>
⑧ ⑨	Set of clamping blocks	<b>KB1700-02</b>
⑩	Pressing star	<b>ADS1706C-O</b>
⑩	Pressing star	<b>ADS1706N-S</b>
	Pressure Safety Valve	<b>DSV1-8</b>
	Plug-in connector customizable Straight - Connector M8	<b>S8-G-3</b>
	<b>Delivery contents</b>	<b>Order no.</b>
⑥	Centering Disc	<b>BDST40600</b>

► Installation Size: **GD1708**

Pos.	Accessories	Order no.
①	Straight Fittings - Quick Connect Style	<b>GV1-8X6</b>
②	Inductive proximity switch - Cable 5 m	<b>NJ8-E2</b>
②	Inductive proximity switch - Connector M8	<b>NJ8-E2S</b>
③	Plug-in connector Straight Cable 5m - Socket M8 (female)	<b>KAG500</b>
③	Plug-in connector Angled Cable 5m - Socket M8 (female)	<b>KAW500</b>
④	Magnetic field sensor Angled Cable 5 m	<b>MFS103KHC</b>
④	Magnetic field sensor Angled Cable 0,3 m - Connector M8	<b>MFS103SKHC</b>
④	Magnetic field sensor Straight Cable 5 m	<b>MFS204KHC</b>
④	Magnetic field sensor Straight Cable 0,3 m - Connector M8	<b>MFS204SKHC</b>
⑤	Cover plate	<b>ADB1708-B</b>
⑦	Universal Jaw Aluminium	<b>UB1708</b>
⑦	Universal Jaw Steel	<b>UB1708ST</b>
⑧ ⑨	Set of clamping blocks	<b>KB1700-02</b>
⑩	Pressing star	<b>ADS1708C-O</b>
⑩	Pressing star	<b>ADS1708N-S</b>
	Pressure Safety Valve	<b>DSV1-8</b>
	Plug-in connector customizable Straight - Connector M8	<b>S8-G-3</b>
	<b>Delivery contents</b>	<b>Order no.</b>
⑥	Centering Disc	<b>BDST40800</b>

► Installation Size: **GD1710**

Pos.	Accessories	Order no.
①	Straight Fittings - Quick Connect Style	<b>GV1-8X6</b>
②	Inductive proximity switch - Cable 5 m	<b>NJ8-E2</b>
②	Inductive proximity switch - Connector M8	<b>NJ8-E2S</b>
③	Plug-in connector Straight Cable 5m - Socket M8 (female)	<b>KAG500</b>
③	Plug-in connector Angled Cable 5m - Socket M8 (female)	<b>KAW500</b>
⑤	Cover plate	<b>ADB1710-B</b>
⑦	Universal Jaw Aluminium	<b>UB1710</b>
⑦	Universal Jaw Steel	<b>UB1710ST</b>
⑩	Pressing star	<b>ADS1710C-O</b>
⑩	Pressing star	<b>ADS1710N-S</b>
	Pressure Safety Valve	<b>DSV1-8</b>
	Plug-in connector customizable Straight - Connector M8	<b>S8-G-3</b>
	<b>Delivery contents</b>	<b>Order no.</b>
⑥	Centering Disc	<b>BDST41000</b>
⑧	Mounting block	<b>KB8-03</b>
⑨	Switch cam + screws	<b>SN0004</b>

► Installation Size: **GD1712**

Pos.	Accessories	Order no.
①	Straight Fittings - Quick Connect Style	<b>GV1-8X6</b>
②	Inductive proximity switch - Cable 5 m	<b>NJ8-E2</b>
②	Inductive proximity switch - Connector M8	<b>NJ8-E2S</b>
③	Plug-in connector Straight Cable 5m - Socket M8 (female)	<b>KAG500</b>
③	Plug-in connector Angled Cable 5m - Socket M8 (female)	<b>KAW500</b>
⑤	Cover plate	<b>ADB1712-B</b>
⑦	Universal Jaw Aluminium	<b>UB1712</b>
⑦	Universal Jaw Steel	<b>UB1712ST</b>
⑩	Pressing star	<b>ADS1712C-O</b>
⑩	Pressing star	<b>ADS1712N-S</b>
	Pressure Safety Valve	<b>DSV1-8</b>
	Plug-in connector customizable Straight - Connector M8	<b>S8-G-3</b>
	<b>Delivery contents</b>	<b>Order no.</b>
⑥	Centering Disc	<b>BDST41000</b>
⑧	Mounting block	<b>KB8-25</b>
⑨	Switch cam + screws	<b>SN0004</b>

► Installation Size: **GD1716**

Pos.	Accessories	Order no.
①	Straight Fittings - Quick Connect Style	<b>GV1-8X6</b>
②	Inductive proximity switch - Cable 5 m	<b>NJ8-E2</b>
②	Inductive proximity switch - Connector M8	<b>NJ8-E2S</b>
③	Plug-in connector Straight Cable 5m - Socket M8 (female)	<b>KAG500</b>
③	Plug-in connector Angled Cable 5m - Socket M8 (female)	<b>KAW500</b>
⑤	Cover plate	<b>ADB1716-B</b>
⑦	Universal Jaw Aluminium	<b>UB1716</b>
⑦	Universal Jaw Steel	<b>UB1716ST</b>
⑩	Pressing star	<b>ADS1716C-O</b>
⑩	Pressing star	<b>ADS1716N-S</b>
	Pressure Safety Valve	<b>DSV1-8</b>
	Plug-in connector customizable Straight - Connector M8	<b>S8-G-3</b>
	<b>Delivery contents</b>	<b>Order no.</b>
⑥	Centering Disc	<b>BDST41600</b>
⑧	Mounting block	<b>KB8-26</b>
⑨	Switch cam + screws	<b>SN0004</b>

# 3-JAW CONCENTRIC GRIPPERS

## SERIES GD1700

### ▶ ACCESSORIES

▶ Installation Size: **GD1720**

Pos.	Accessories	Order no.
①	Straight Fittings - Quick Connect Style	<b>GV1-4X8</b>
②	Inductive proximity switch - Cable 5 m	<b>NJ8-E2</b>
②	Inductive proximity switch - Connector M8	<b>NJ8-E2S</b>
③	Plug-in connector Straight Cable 5m - Socket M8 (female)	<b>KAG500</b>
③	Plug-in connector Angled Cable 5m - Socket M8 (female)	<b>KAW500</b>
⑤	Cover plate	<b>ADB1720-B</b>
⑦	Universal Jaw Aluminium	<b>UB1720</b>
⑦	Universal Jaw Steel	<b>UB1720ST</b>
⑩	Pressing star	<b>ADS1720C-O</b>
⑩	Pressing star	<b>ADS1720N-S</b>
	Pressure Safety Valve	<b>DSV1-8</b>
	Plug-in connector customizable Straight - Connector M8	<b>S8-G-3</b>
	<b>Delivery contents</b>	<b>Order no.</b>
⑥	Centering Disc	<b>BDST42000</b>
⑧	Mounting block	<b>KB8-27</b>
⑨	Switch cam + screws	<b>SN0004</b>